

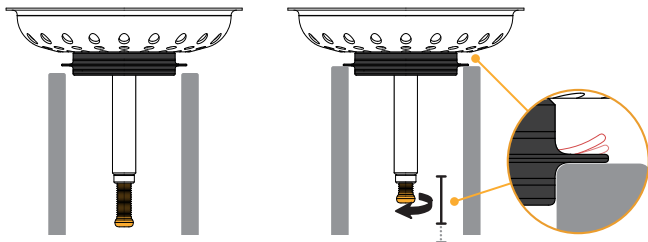

FUNKTION
FUNCTION



SCHOCK



COMFOPUSH

ART.NO. 629891CHR / 629891EDM

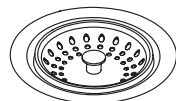

PFLEGE- UND MONTAGEANLEITUNG (D)

INSTALLATION AND CARE INSTRUCTION (EN)

NOTICE DE NETTOYAGE ET DE MONTAGE (FR)

ISTRUZIONI DI INSTALLAZIONE E MANUTENZIONE (IT)

INSTRUCCIONES DE LIMPIEZA Y MONTAJE (ES)

РЕКОМЕНДАЦИИ ПО УХОДУ, ИНСТРУКЦИИ ПО МОНТАЖУ (RU)



MONTAGEANLEITUNG
INSTALLATION INSTRUCTION

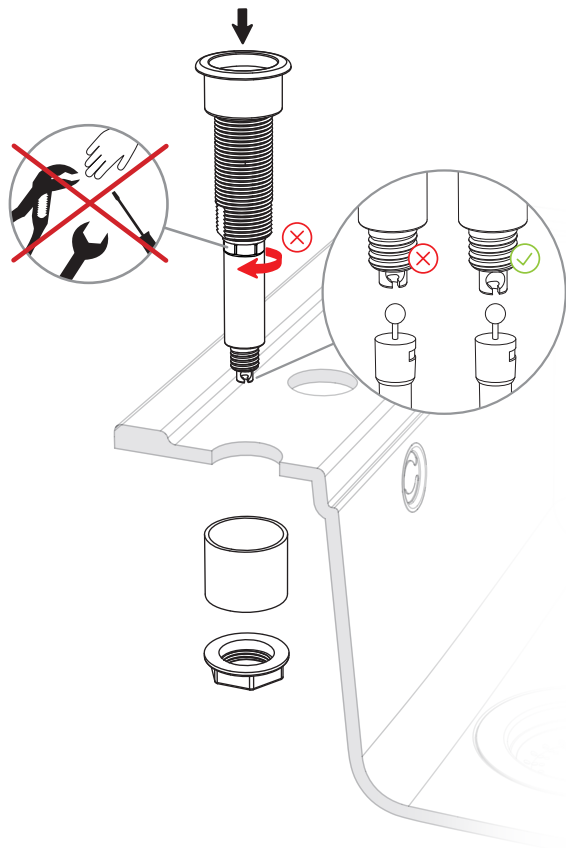

PFLEGEANLEITUNG
CARE INSTRUCTIONS



1.

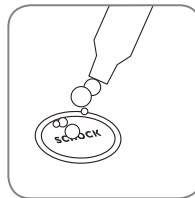

2.

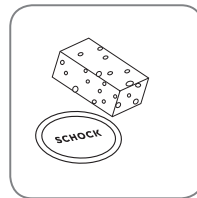

3.

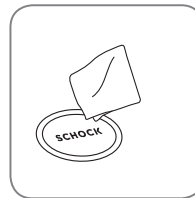

1.

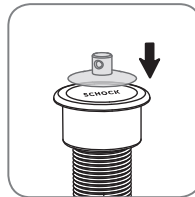

2.

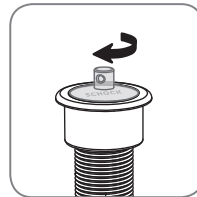

3.

