

SCHOCK

CRISTADUR®

GREENWICH N-150

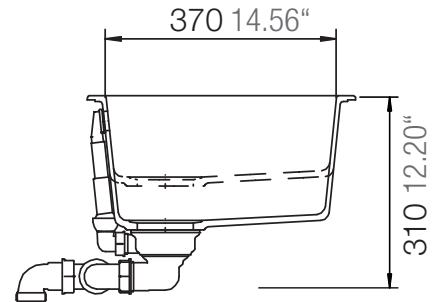
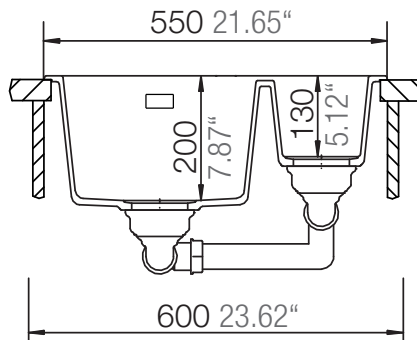
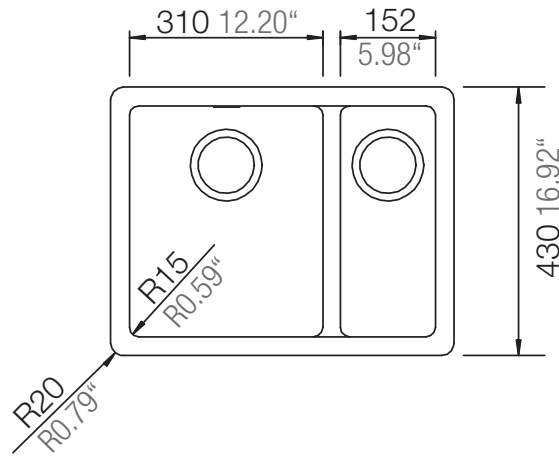

Installation: Von oben / topmount
Ausschnitt / cut-out

Installation: Unterbau / undermount
Ausschnitt / cut-out

