

SCHOCK

CRISTALITE®

FORMHAUS D-150L

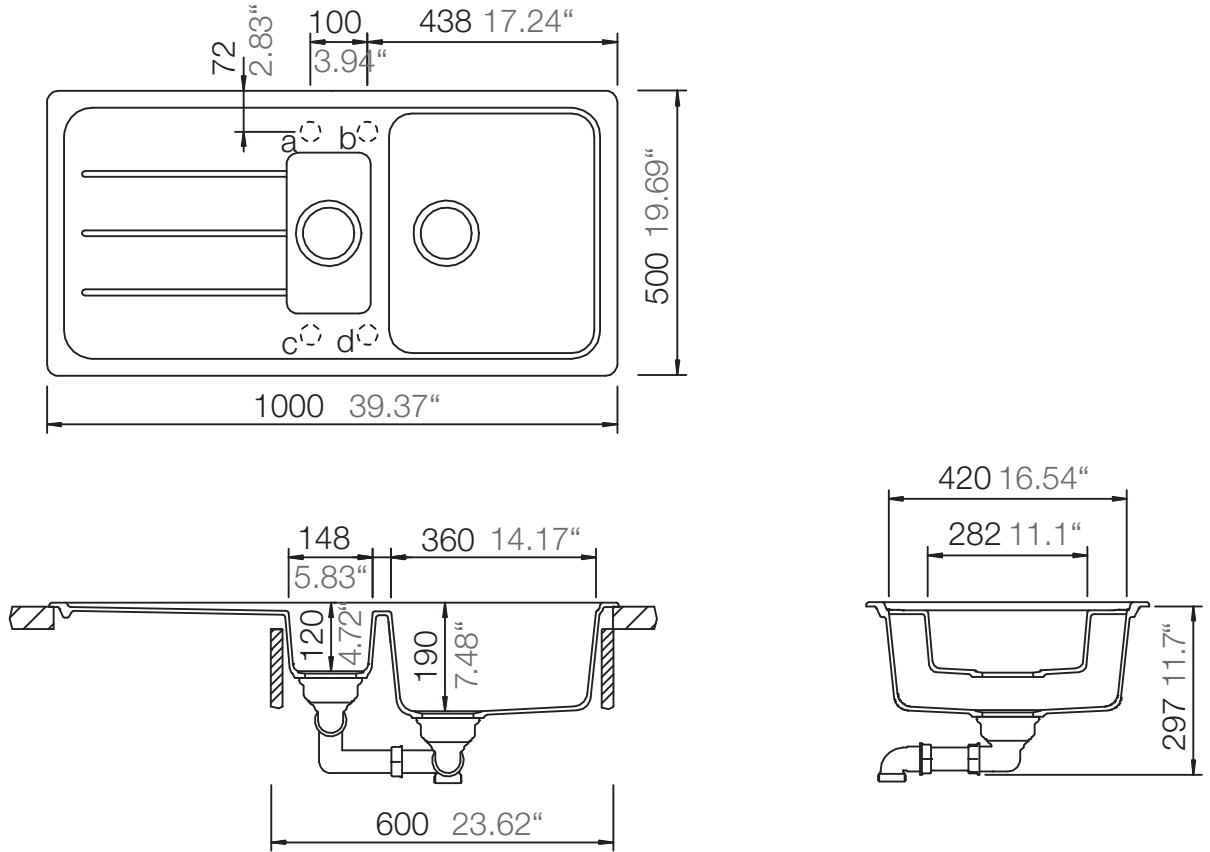

Installation: Von oben / topmount
Ausschnitt / cut-out

Installation: Unterbau / undermount
Ausschnitt / cut-out

